

## Description

The DCSCM05C is a bi-directional TVS diode array, utilizing leading monolithic silicon technology to provide fast response time and low ESD clamping voltage, making this device an ideal solution for protecting sensitive semiconductor components from damage. The DCSCM05C complies with the IEC 61000-4-2 (ESD) standard with  $\pm 30\text{kV}$  air and  $\pm 30\text{kV}$  contact discharge. It is assembled into a lead-free SOT-23 package. It is designed to protect components which are connected to data and transmission lines from voltage surges.

## Mechanical Characteristics

- ◆ Package: SOT-23
- ◆ Lead Finish: Matte Tin
- ◆ Case Material: "Green" Molding Compound.
- ◆ UL Flammability Classification Rating 94V-0
- ◆ Moisture Sensitivity: Level 3 per J-STD-020
- ◆ Terminal Connections: See Diagram Below
- ◆ Marking Information: See Below

## Dimensions and Pin Configuration

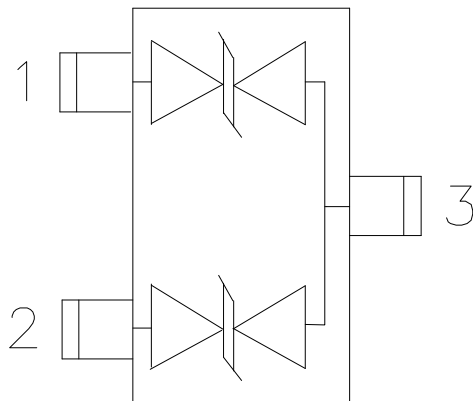

Circuit and Pin Schematic

## Features

- ◆ 300W peak pulse power(8/20 $\mu\text{s}$ )
- ◆ Protects two bi-directional lines
- ◆ Ultra low leakage: nA level
- ◆ Operating voltage: 5V
- ◆ Low clamping voltage
- ◆ Complies with following standards:
  - IEC 61000-4-2 (ESD) immunity test
    - Air discharge:  $\pm 30\text{kV}$
    - Contact discharge:  $\pm 30\text{kV}$
  - IEC61000-4-4 (EFT) 40A (5/50ns)
- ◆ RoHS Compliant

## Applications

- ◆ Cellular Handsets and Accessories
- ◆ Notebooks and Handhelds
- ◆ Portable Instrumentation
- ◆ Set Top Box
- ◆ Industrial Controls
- ◆ Server and Desktop PC

## Marking Information

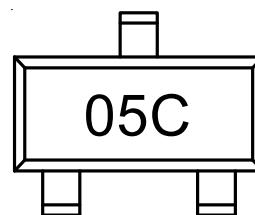

## Ordering Information

Part Number	Marking	Packaging	Reel Size
DCSCM05C	05C	3000/Tape & Reel	7 inch

### Absolute Maximum Ratings ( $T_A=25^{\circ}\text{C}$ unless otherwise specified)

Parameter	Symbol	Value	Unit
Peak Pulse Power(8/20 $\mu\text{s}$ )	Ppk	300	W
ESD per IEC 61000-4-2 (Air)	V <sub>ESD</sub>	$\pm 30$	kV
ESD per IEC 61000-4-2 (Contact)		$\pm 30$	
Operating Temperature Range	T <sub>J</sub>	-55 to +125	$^{\circ}\text{C}$
Storage Temperature Range	T <sub>stg</sub>	-55 to +150	$^{\circ}\text{C}$

### Electrical Characteristics ( $T_A=25^{\circ}\text{C}$ unless otherwise specified)

Parameter	Symbol	Min	Typ	Max	Unit	Test Condition
Reverse Working Voltage	V <sub>RWM</sub>			5	V	
Breakdown Voltage	V <sub>BR</sub>	6			V	I <sub>T</sub> = 1mA
Reverse Leakage Current	I <sub>R</sub>			0.5	$\mu\text{A}$	V <sub>RWM</sub> = 5 V
Clamping Voltage	V <sub>C</sub>			9	V	I <sub>PP</sub> = 1A (8 x 20 $\mu\text{s}$ pulse)
Clamping Voltage	V <sub>C</sub>			15	V	I <sub>PP</sub> = 25A (8 x 20 $\mu\text{s}$ pulse)
Peak Pulse Current	I <sub>PP</sub>			25	A	t <sub>P</sub> =8/20 $\mu\text{s}$
Junction Capacitance	C <sub>J</sub>		30		pF	V <sub>R</sub> =0, f=1MHz, Pin 1 to Pin 2 or Pin 2 to Pin 1

**Typical Performance Characteristics (TA=25°C unless otherwise Specified)**

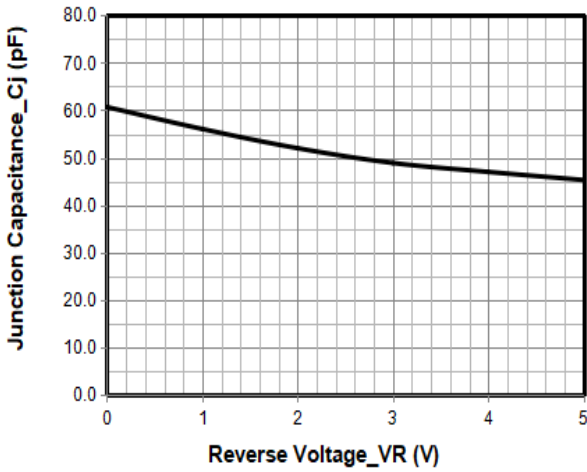

Junction Capacitance vs. Reverse Voltage

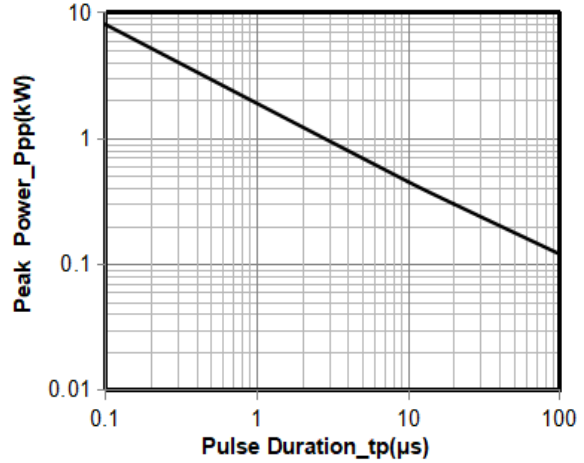

Peak Pulse Power vs. Pulse Time

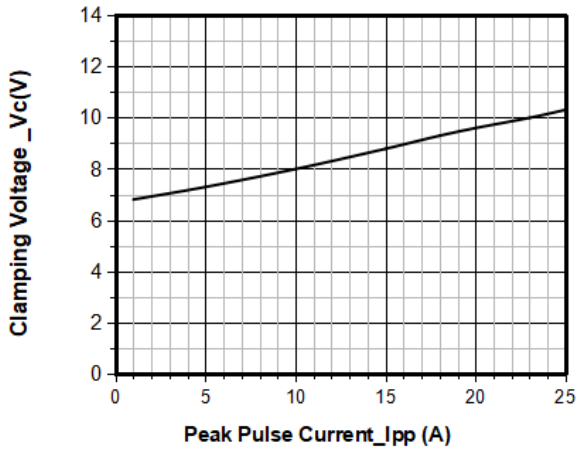

Clamping Voltage vs. Peak Pulse Current

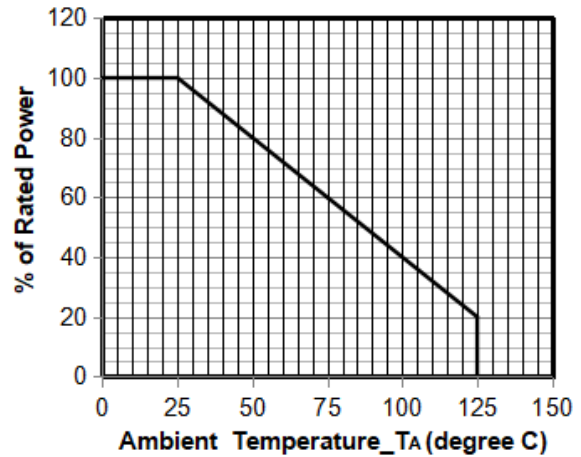

Power Derating Curve

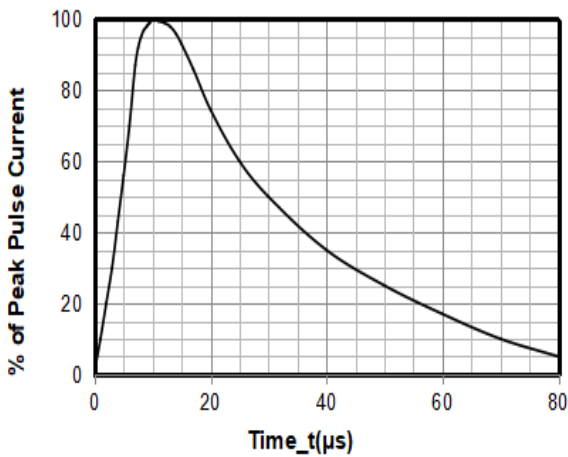

8 X 20μs Pulse Waveform

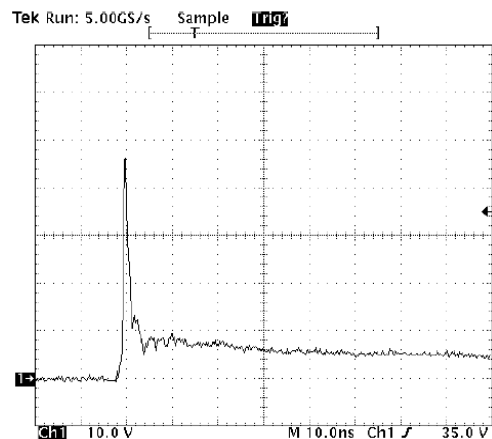

Note: Data is taken with a 10x attenuator

ESD Clamping Voltage

8 kV Contact per IEC61000-4-2

### SOT-23 Package Outline Drawing

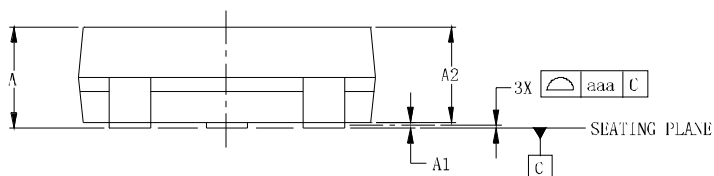
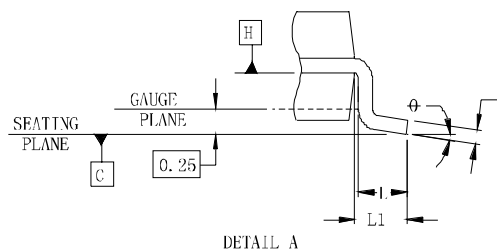
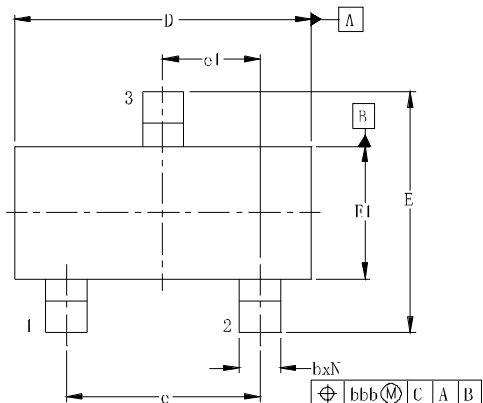

DIMENSIONS						
SYM	INCHES			MILLIMETERS		
	MIN	NOM	MAX	MIN	NOM	MAX
A	0.035	-	0.044	0.89	-	1.12
A1	0.000	-	0.004	0.01	-	0.10
A2	0.035	0.037	0.040	0.88	0.95	1.02
b	0.012	-	0.020	0.30	-	0.51
c	0.003	-	0.007	0.08	-	0.18
D	0.110	0.114	0.120	2.80	2.90	3.04
E	0.082	0.093	0.104	2.10	2.37	2.64
E1	0.047	0.051	0.055	1.20	1.30	1.40
e	0.075			1.90BSC		
e1	0.037			0.95BSC		
L	0.015	0.020	0.024	0.40	0.50	0.60
L1	0.022			0.55		
N	3			3		
ϕ	0°	-	8°	0°	-	8°
aaa	0.004			0.10		
bbb	0.008			0.20		

### Suggested Land Pattern

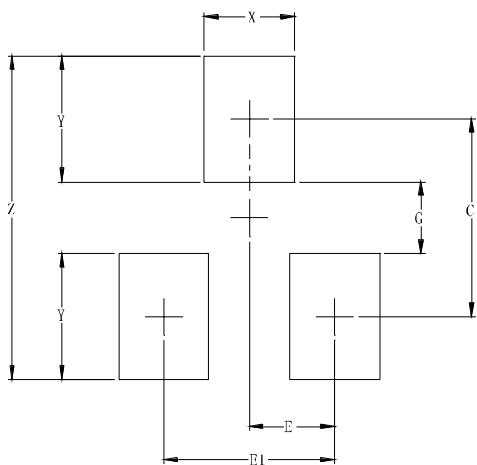

DIMENSIONS		
SYM	INCHES	MILLIMETERS
C	0.087	2.20
E	0.037	0.95
E1	0.075	1.90
G	0.031	0.80
X	0.039	1.00
Y	0.055	1.40
Z	0.141	3.60

### Contact Information

Changzhou D-first Electronics CO.,Ltd.

www.first-electronic.com

Email: xhf@first-electronic.cn

Phone: +86 (0519) 8817 1671